

1500 Series 1506A-E88TAG4 ElectropaK

267 kWm standby net power @ 1500 rpm

Building upon Perkins proven reputation within the power generation industry the Perkins® 1500 Series ElectropaK engines now fit even closer to our customer's needs.

The 1506A-E88TAG4 ElectropaK is a 6 cylinder, fully electronic, turbocharged, air-to-air charge cooled diesel engine. It is economical, quiet and reliable and provides the high performance that is demanded by our customers for their power generation needs.

Focusing on the Perkins common platform theme, changes to engine envelope dimensions and connection points have been kept to a minimum, making for easy installation across the ratings.



Specification		
Number of cylinders	6 vertical in-line	
Bore and stroke	112 x 149 mm	4.5 x 5.8 in
Displacement	8.8 litres	537 in ³
Aspiration	Turbocharged aftercooled	
Cycle	4 stroke	
Combustion system	Direct injection	
Compression ratio	16.1:1	
Rotation	Anti-clockwise, viewed on flywheel	
Total lubricating capacity	41 litres	9.01 US gal
Cooling system	Liquid	

www.perkins.com

Photographs are for illustrative purposes only and may not reflect final specification. All information in this document is substantially correct at time of printing and may be altered subsequently. Final weight and dimensions will depend on completed specification.

Publication No. PN3089A/04/15 Produced in England ©2015 Perkins Engines Company Limited

 **Perkins®**

THE HEART OF EVERY GREAT MACHINE

1500 Series 1506A-E88TAG4 ElectropaK

267 kWm standby net power @ 1500 rpm

Features and benefits

Dependable power

- The 1506A-E88TAG4 delivers greater productivity through an improved power to weight ratio
- The world-class power density has been achieved from an 8.8 litre turbocharged engine using a hydraulic actuated unit injection (HEUI) fuel system; making this engine robust for all markets due to its ability to cope with the variation of fuel quality around the world
- In its class, the 1506A-E88TAG4 has been designed to provide dependable power even in extreme ambient climates

Low operating costs

- Oil change service intervals are set at 500 hours as standard
- Designed to provide low cost of ownership, simple maintenance and reduced downtime
- 12 months unlimited warranty with 24 months on Major items. For low use applications <500 hours per year warranty is extended by a further 12 months. See Perkins Warranty Policy for further details
- Extended Service Contracts – protect and plan the cost of ownership
Go to www.perkins.com/esc for more information

Flexibility

- The 1506-E88TAG4 has been designed to hit the power node requirements of our customers
- Switchability functionality from 50 Hz/1500 rpm to 60 Hz/1800 rpm and vice versa is available to provide greater flexibility for frequency selection

World class product support

- Our experienced global network of distributors and dealers, fully trained engine experts deliver total service support around the clock, 365 days a year. They have a comprehensive suite of web based tools at their disposal, covering technical information, parts identification and ordering systems, all dedicated to maximising the productivity of your engine
- Perkins actively pursues product support excellence by insisting our distribution network invest in their territory to provide customers with a consistent quality of support across the globe
- Throughout the entire life of a Perkins engine, we provide access to genuine OE specification parts giving 100% reassurance that you receive the very best in terms of quality for lowest possible cost, wherever your Perkins powered machine is operating in the world
- To find your local distributor: www.perkins.com/distributor

www.perkins.com

Photographs are for illustrative purposes only and may not reflect final specification.
All information in this document is substantially correct at time of printing and may be altered subsequently.
Final weight and dimensions will depend on completed specification.

Publication No. PN3089A/04/15 Produced in England ©2015 Perkins Engines Company Limited

 **Perkins**[®]

THE HEART OF EVERY GREAT MACHINE

1500 Series 1506A-E88TAG4 ElectropaK

267 kWm standby net power @ 1500 rpm

Technical information

Air inlet system

- Mounted air filter and turbocharger

Fuel system

- HEUI fuel system with full authority electronic control
- Electronic governing to ISO 8528-5 with stand-alone isochronous and load-sharing capabilities
- Fuel filter, fuel transfer pump, fuel priming pump
- Spin on primary, secondary and water filter separator

Lubrication system

- Wet full aluminium sump with filler and dipstick
- Full-flow spin-on filters
- Oil pump, gear driven

Cooling system

- Thermostatically controlled with belt driven, circulating pump and belt-drive fan
- Mounted belt driven pusher fan
- Radiator supplied loose with all guards and pipes
- Air-to-air charge cooler incorporated in radiator

Electrical equipment

- 24V starter motor and 24V, 45 amp alternator with DC output
- Electronic Control Module (ECM) mounted on engine with wiring looms and sensors

Flywheel and housing

- High inertia flywheel to SAE 1 J620 Size 355.6 mm (14 in)
- Aluminium SAE 1 flywheel housing

Mountings

- Front engine mounting bracket

www.perkins.com

Photographs are for illustrative purposes only and may not reflect final specification.
All information in this document is substantially correct at time of printing and may be altered subsequently.
Final weight and dimensions will depend on completed specification.

Publication No. PN3089A/04/15 Produced in England ©2015 Perkins Engines Company Limited

 **Perkins**[®]

THE HEART OF EVERY GREAT MACHINE

1500 Series 1506A-E88TAG4 ElectropaK

267 kWm standby net power @ 1500 rpm

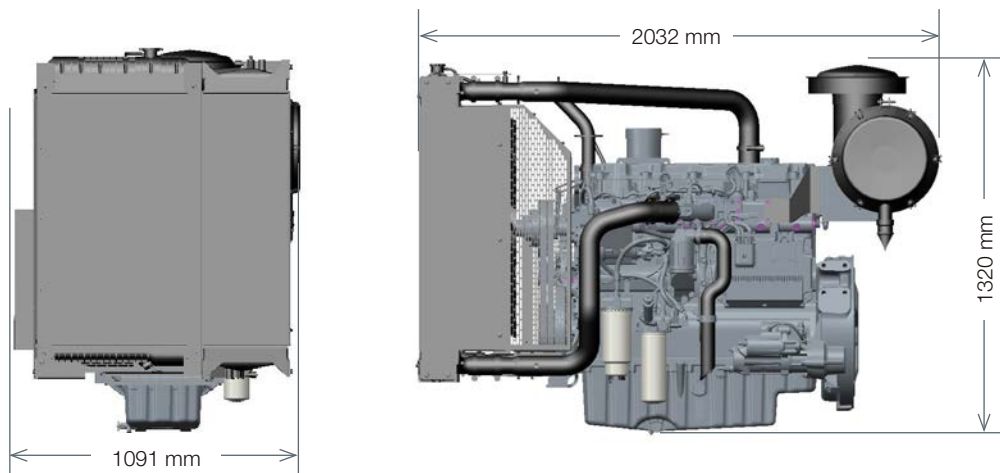

Engine package weights and dimensions

Length (including air cleaner)	2032 mm	80 in
Width	1091 mm	43 in
Height	1320 mm	52 in
Weight (dry)	1183 kg	2608 lb

www.perkins.com

Photographs are for illustrative purposes only and may not reflect final specification.
All information in this document is substantially correct at time of printing and may be altered subsequently.
Final weight and dimensions will depend on completed specification.

Publication No. PN3089A/04/15 Produced in England ©2015 Perkins Engines Company Limited

 **Perkins**[®]

THE HEART OF EVERY GREAT MACHINE

1500 Series 1506A-E88TAG4 ElectropaK

267 kWm standby net power @ 1500 rpm

Speed rpm	Type of operation	Typical generator output		Engine power (Net)	
		kVA	kWe	kWm	hp
1500	Prime power	275	220	244	327
	Standby power	300	240	267	358

Percent of prime power	Fuel consumption at 1500 rpm g/kWh	Fuel consumption at 1500 rpm l/hr
Standby power	200	66
Prime power	198	60
75%	200	46
50%	207	32

www.perkins.com

Photographs are for illustrative purposes only and may not reflect final specification.
All information in this document is substantially correct at time of printing and may be altered subsequently.
Final weight and dimensions will depend on completed specification.

Publication No. PN3089A/04/15 Produced in England ©2015 Perkins Engines Company Limited



THE HEART OF EVERY GREAT MACHINE